

SUBMATIC S 2HP

CONTROLLO DI LIVELLO ELETTRONICO

Il controllo di livello SUB/MATIC S 2HP si differenzia dalle apparecchiature di controllo a circuito elettronico similari per nuove funzioni ed un innovativo principio di funzionamento.

SUB MATIC S 2Hp è dotato di:

- alimentazione multitensione 24V-220/230V- 400V c.a. (a richiesta 110 V. c.a.)
 - uscita in bassa tensione per il collegamento al pressostato di comando dell'elettropompa o galleggiante di riempimento/svuotamento
 - uscita a relais per comando motore: 2Hp 230V c.a.
 - leds di segnalazione:
 - presenza rete -marcia pompa
 - mancanza acqua
 - interruttore: automatico/manuale
 - ripetizione segnale di mancanza acqua con relay 1Hp 230 V c.a.
- Tensione Agli Elettrodi 12V c.a.
Relè Per Comando Motori Fino a 2HP

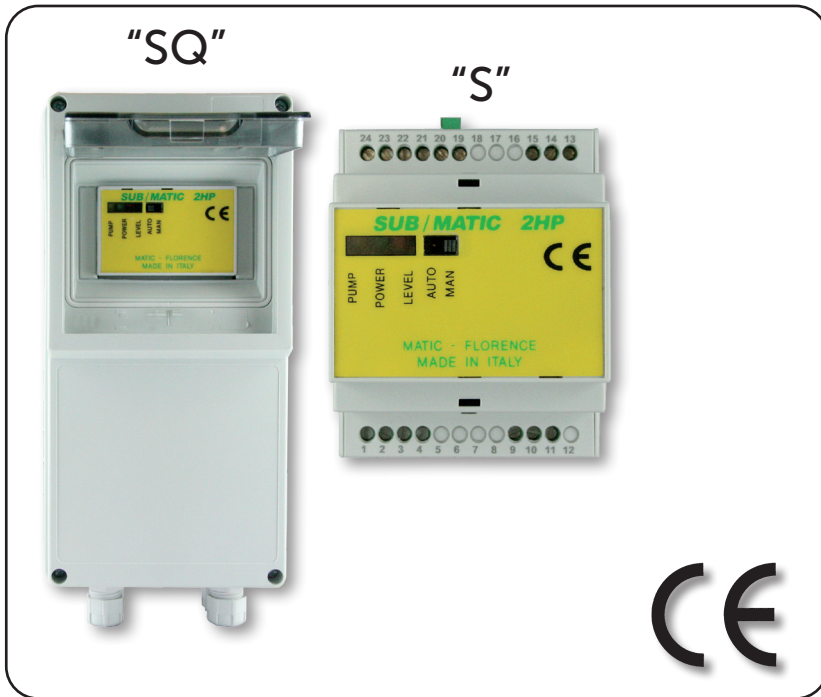

ELECTRONIC LEVEL CONTROL

The level regulator SUB/MATIC is different from the other similar electronic circuit devices thanks to new functions and to a revolutionary working principle.

SUB MATIC S 2Hp is complete of:

- multi voltage feeding 24V-220/230V-400V a.c.110V a.c. on request)
- low tension output for the connection to the pressure switch or level regulator for emptying/ filling
- relays exit for motor control: 2Hp 230V a.c.
- leds:
 - power
 - pump on
 - dry running
- switch: automatic/manual
- dry running signal repeater relay 1 Hp 230 V a.c.

Electrode Voltages: 12 V. A.C.

Relay For Motor Control Up To 2HP

CODIFICAZIONE

D A C [] [] []

Tipo-Type

S = modulo barra DIN rail module

Q = contenitore a parete-plastic box

Alimentazione-Power Supply

1 = 24 - 230 - 380 V a.c.

2 = 110V a.c.

Accessori-Accessories

0 = nessun accessorio - no accessories included

K = 3 sonde unipolari "S" incluse nella confezione

3 single pole probes "S" included into the single packing carton box

INSTALLAZIONE / INSTALLATION

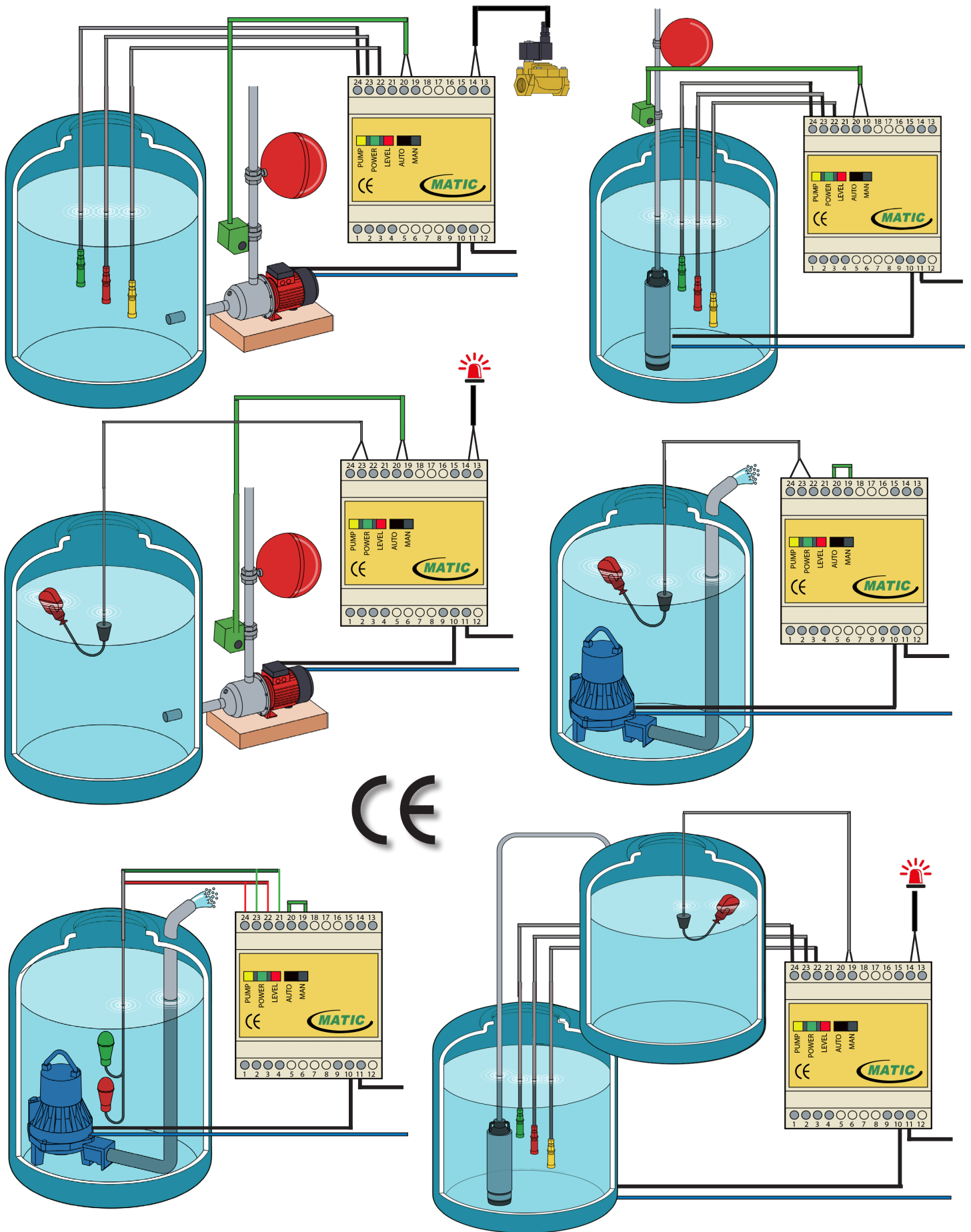

SONDE / PROBES

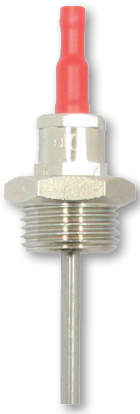

Sonda a Singolo Elettrodo Inox 304 e Filettatura 1/2" in Ottone Nichelato.
Misura Standard Dell'Elettrodo cm 12 a Richiesta misure Fino ad 1 metro.
Pressione Max 8 bar - Temperatura Acqua Max 55°C

Single Pole Probe With Stain Less Steel 304 Electrode and 1/2" Brass Screw. Elec-
trode Standard Length 12 cm on Request Different length up to 1 meter.
Max Pressure 8 bar - Water Max Temperature 55°C

Lunghezza elettrodo standard : cm 12
in alternativa indicare la lunghezza in centimetri
esempio:
Standard Electrode Length: cm 12
alternatively indicate the required Length in centi-
meters
Example: 1 cm = 01 - 30 cm = 30

CODIFICAZIONE				
H	A	B		



Sonda a Singolo Elettrodo Inox 304 Completa Di Passacavo in PVC.
Temperatura Acqua Max 40°C - Ø 20 mm x 94 mm

Single Pole Probe inox 304 Complete with PVC Cover and Cable Gland
Max Water Temperature 40°C- Ø 20 mm x 94 mm

CODIFICAZIONE		
H	A	A



Sonda a Doppio Elettrodo Inox 304 e Filettatura 1/2" in PVC.
Misura Standard Degli Elettrodi cm 3 a Richiesta misure Fino ad 1 metro
Pressione Max 8 bar - Temperatura Acqua Max 40°C

Double Poles Probe With Stain Less Steel 304 Electrode and 1/2" PVC Screw.
Electrode Standard Length 3 cm on Request Different length up to 1 meter
Max Pressure 8 bar - Water Max Temperature 40°C

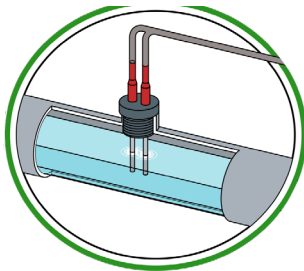

Lunghezza elettrodo standard : cm 12
in alternativa indicare la lunghezza in centimetri
esempio:
Standard Electrode Length: cm 12
alternatively indicate the required Length in centi-
meters
Example: 1 cm = 01 - 30 cm = 30

CODIFICAZIONE				
H	A	B		



Sonda a Doppio Elettrodo Inox 304 Completa Di Cavo e Custodia in PVC.
La connessione Tra Elettrodo e Cavo e' Sigillata Ermeticamente ad evitare l'ossi-
dazione del conduttore in rame ed il distacco degli elettrodi - Temperatura Acqua
Max 40°C - Ø 30 mm x 155 mm.

Double Pole Probe inox 304 Complete with PVC Cover and Cable. The connection between
the electrodes and the copper wire is totally insulated by an epossidic resin against oxidation
and detachment of the electrodes. Max Pressure 8 Bar - Water Max Temp. 40°C
Ø 30 mm x 155 mm.

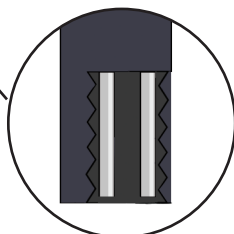

Lunghezza Del Cavo - Cable Length
01 = 1 metro - meter
10 = 10 metri - meters

CODIFICAZIONE				
H	A	C		

SONDE / PROBES



CONTRAPPESO Sonda a Doppio Elettrodo Inox 304 per allarme TROPPO PIENO. da collegare al BEEPER o SUB MATIC o CONTROL PUMP PLUS

COUNTERWEIGHT Double Pole Probe Inox 304 for TOO HIGH LEVEL ALARM. to be connected to BEEPER or SUB MATIC or CONTROL PUMP PLUS.

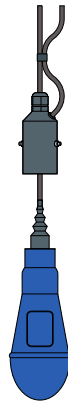
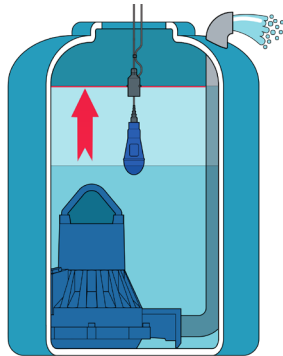

CODIFICAZIONE
H A E

Lunghezza Del Cavo - Cable Length
01 = 1 metro - meter
10 = 10 metri - meters

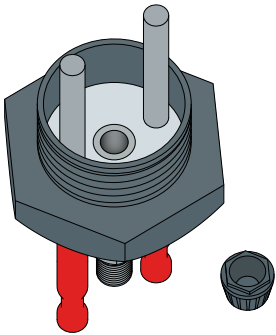

Sonda a Doppio Elettrodo Inox 304 e Filettatura 1" in PVC. Completa Di Pozzetto Raccolta acqua e Valvola Di Scarico.

Double Poles Probe With Stain Less Steel 304 Electrode and 1" PVC Screw. Complete With Water Collection Space and Discharging valve

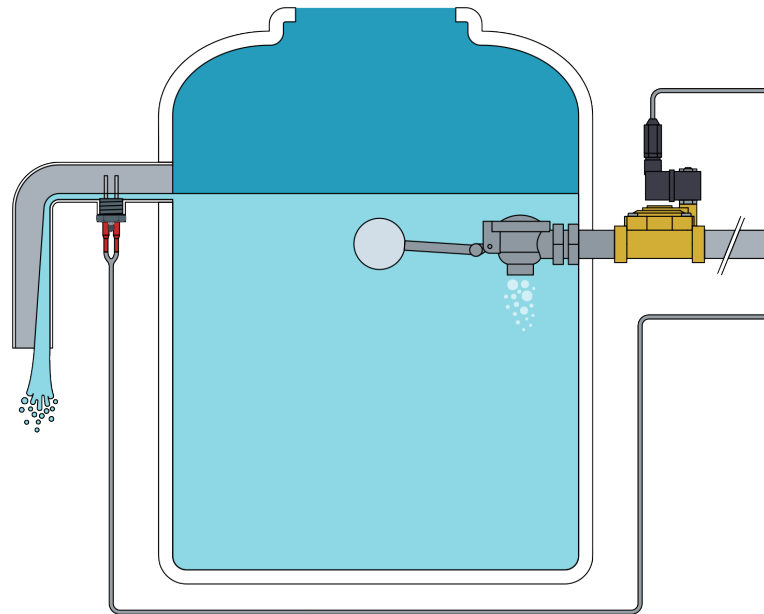
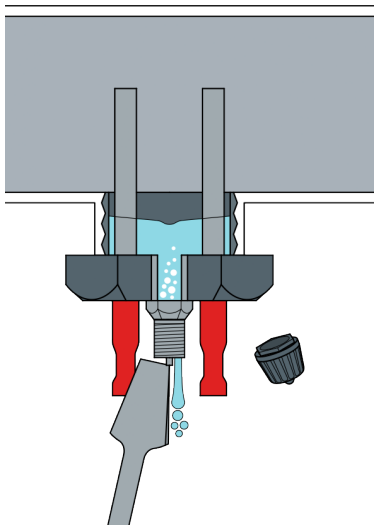

CODIFICAZIONE
H A L 1 S



sonda ANTI ALLAGAMENTO
ANTI FLOODING probe

Sonda per la rilevazione dell'acqua sul pavimento,
Anti flooding probe suitable for detecting water on the floor

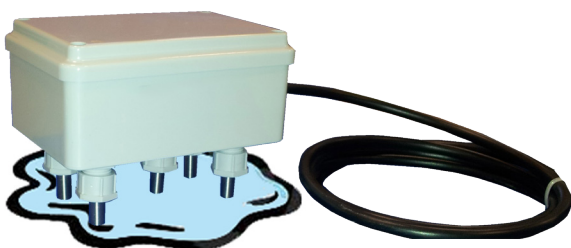

Lunghezza cavo-Cable length
02 = 2 metri standard - 2 meters standards
in alternativa indicare la lunghezza in metri, es:
alternatively indicate the cable length expressed
in meters,
3 metri - meters = 03
10 metri - meters = 10

CODIFICAZIONE
H A D